

## Hydraulic Crawler Crane

# 7120S

Model : 7120S

- Max. Lifting Capacity: **120 t x 5.0 m**
- Max. Lifting Capacity With Tower Jib: **20.0 t x 15.0 m**
- Max. Crane Boom Length: **61.0 m**
- Max. Long Boom Length: **79.2 m**
- Max. Fixed Jib Combination: **61.0 m + 30.5 m**
- Max. Tower Jib Combination: **51.7 m + 44.2 m**

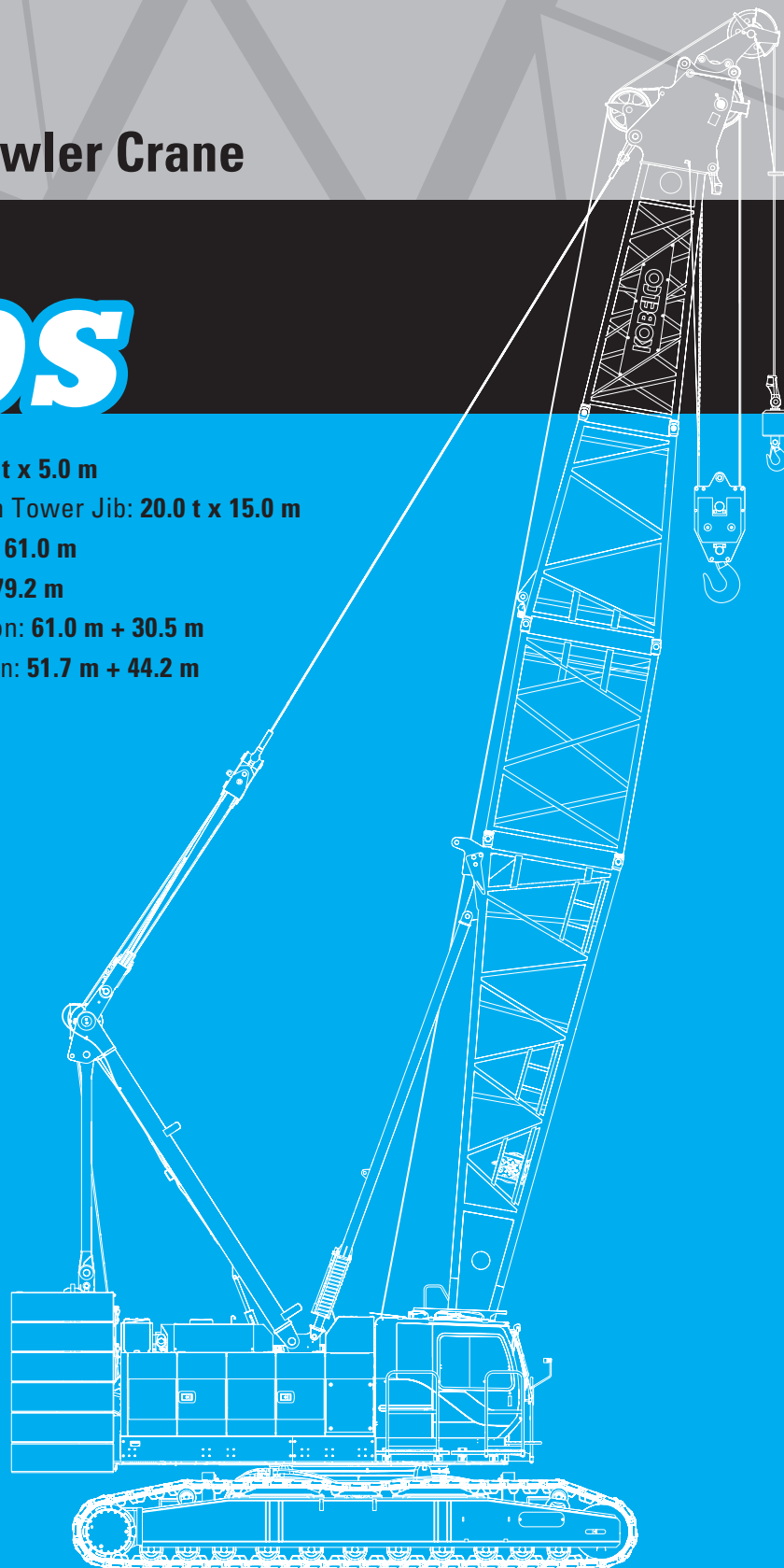

# KOBELCO



# **7120S**

## **CONTENTS**

<b>3</b>	<b>SPECIFICATIONS</b>
<b>5</b>	<b>GENERAL DIMENSIONS</b>
<b>7</b>	<b>BOOM AND JIB ARRANGEMENTS</b>
<b>10</b>	<b>WORKING RANGES</b>
<b>15</b>	<b>SUPPLEMENTAL DATA</b>
<b>16</b>	<b>LIFTING CAPACITIES</b>
<b>24</b>	<b>SUPPLEMENTAL DATA</b>
<b>25</b>	<b>LIFTING CAPACITIES</b>
<b>31</b>	<b>GENERAL DIMENSION FOR CLAMSHELL</b>
<b>32</b>	<b>WORKING RANGE FOR CLAMSHELL</b>
<b>33</b>	<b>SUPPLEMENTAL DATA FOR CLAMSHELL</b>
<b>34</b>	<b>LIFTING CAPACITIES FOR CLAMSHELL</b>
<b>35</b>	<b>SUPPLEMENTAL DATA FOR REDUCED WEIGHTS</b>
<b>36</b>	<b>LIFTING CAPACITIES FOR REDUCED WEIGHTS</b>
<b>37</b>	<b>SUPPLEMENTAL DATA FOR BARGE</b>
<b>38</b>	<b>LIFTING CAPACITIES FOR BARGE</b>
<b>39</b>	<b>TRANSPORTATION PLAN</b>
<b>43</b>	<b>PARTS AND ATTACHMENTS</b>

# SPECIFICATIONS



## Power Plant

**Model:** HINO P11C-VH

**Type:** 4 cycle, water-cooled, vertical in-line 6, direct injection, turbo-charger, intercooler

**Displacement:** 10,520 liters

**Rated power:** 271 kW/1,850 min<sup>-1</sup>

**Max. Torque:** 1,469 N·m/1,400 min<sup>-1</sup>

**Cooling System:** Water-cooled

**Starter:** 24V-6kW

**Radiator:** Corrugated type core, thermostatically controlled

**Air cleaner:** Dry type with replaceable paper element

**Throttle:** Twist grip type hand throttle, electrically actuated

**Fuel filter:** Replaceable paper element

**Batteries:** Two 12 V x 136 Ah/5HR capacity batteries, series connected

**Fuel tank capacity:** 400 liters



## Hydraulic System

**Main pumps:** 4 variable displacement piston pumps

**Control:** Full-flow hydraulic control system for infinitely variable pressure to all winches, propel and swing. Controls respond instantly to the touch, delivering smooth function operation.

**Cooling:** Oil-to-air heat exchanger (plate-fin type)

**Filtration:** Full-flow and bypass type with replaceable element

**Max. relief valve pressure:**

**Load hoist, boom hoist and propel system:** 31.9 MPa

**Swing system:** 27.5 MPa

**Control system:** 5.4 MPa

**Hydraulic Tank Capacity:** 535 liters



## Boom Hoisting System

Powered by a hydraulic motor through a planetary reducer.

**Brake:** A spring-set, hydraulically released multiple-disc brake is mounted on the boom hoist motor and operated through a counter-balance valve.

**Drum Lock:** External ratchet for locking drum

**Drum:** Single drum, grooved for 20 mm dia. wire rope

**Line Speed:** Single line on first drum layer

**Hoisting/Lowering:** 48 to 2 m/min

**Boom hoisting/lowering:** 20 mm x 190 m

**Boom guy line:** 30 mm

**Boom backstops:** Required for all boom length



## Load Hoisting System

Front and rear drums for load hoist powered by a hydraulic variable plunger motors, driven through planetary reducers.

**Negative Brake:** A spring-set, hydraulically released multiple-disc brake is mounted on the hoist motor and operated through a counter-balance valve. (Positive free fall brake is optional)

**Drum Lock:** External ratchet for locking drum

**Drums:**

**Front Drums:**

666 mm P.C.D x 672 mm wide drum, grooved for 26 mm wire rope. Rope capacity is 275 m working length and 350 m storage length.

**Rear Drum:** 666 mm P.C.D x 672 mm, grooved for 26 mm wire rope. Rope capacity is 255 m working length and 350 m storage length.

**Diameter of wire rope**

**Main winch:** 26 mm x 275 m

**Aux. winch:** 26 mm x 255 m

**Third winch:** 26 mm x 240 m

**Line Speed\*:**

**Hoisting/lowering:** 120 to 3 m/min

**Line Pull:**

**Max. Line Pull\*:** 233 kN {23.8 tf}  
(Referential performance)

**Rated Line Pull:** 118 kN {12.0 tf}

\*Single line on first drum layer



## Swing System

Swing unit is powered by hydraulic motor driving spur gears through planetary reducer, the swing system provides 360° rotation.

**Swing parking brakes:** A spring-set, hydraulically released multiple-disc brake is mounted on swing motor.

**Swing circle:** Single-row ball bearing with an integral internally cut swing gear.

**Swing lock:** Manually, four position lock for transportation

**Swing Speed:** 2.1 min<sup>-1</sup>



## Upper Structure

Torsion-free precision machined upper frame. All components are located clearly and service friendly. Engine will with low noise level.

**Counterweight:** 53.1 ton



## Cab & Control

Totally enclosed, full vision cab with safety glass, fully adjustable, high backed seat with a headrest and armrests, and intermittent wiper and window washer (skylight and front window).

### Cab fittings:

Air conditioner, convenient compartment (for tool), cup holder, cigarette lighter, sun visor, roof blind, tinted glass, floor mat, footrest, and shoe tray



### Lower Structure

Steel-welded carbody with axles. Crawler assemblies are designed with quick disconnect feature for individual removal as a unit from axles. Crawler belt tension is maintained by hydraulic jack force on the track adjusting bearing block.

**Crawler drive:** Independent hydraulic propel drive is built into each crawler side frame. Each drive consists of a hydraulic motor propelling a driving tumbler through a planetary gear box. Hydraulic motor and gear box are built into the crawler side frame within the shoe width.

**Crawler brakes:** Spring-set, hydraulically released parking brakes are built into each propel drive.

**Steering mechanism:** A hydraulic propel system provides both skid steering (driving one track only) and counter-rotating steering (driving each track in opposite directions).

**Track rollers:** Sealed track rollers for maintenance-free operation.

**Shoe (flat):** 910 mm wide each crawler

**Max. gradeability:** 30%



### Weight

Including upper and lower machine, 53.1 ton counterweight and basic boom (or basic boom + basic jib), hook, and other accessories.

**Weight:** 120 ton

**Ground pressure:** 93.6 kPa



### Attachment

#### Boom & Jib:

Welded lattice construction using tubular, high-tensile steel chords with pin connection between sections.

#### Boom and Jib length

	Min. Length (Min. combination)	Max. Length (Max. combination)
Crane Boom	15.2 m	61.0 m
Fixed Jib	24.4 m + 12.2 m	61.0 m + 30.5 m

## Main Specifications (Model: 7120S)

Crane Boom	
Max. Lifting Capacity	120 t x 5.0 m
Max. Length	61.0 m
Fixed Jib	
Max. Lifting Capacity	12.0 t x 28.0 m
Max. Combination	61.0 m + 30.5 m
Long Boom	
Max. Lifting Capacity	24.0 t x 16.0 m
Max. Length	79.2 m
Tower Jib	
Max. Lifting Capacity	20.0 t x 15.0 m
Max. Jib Length	44.2 m
Max. Combination	51.7 m + 44.2 m
Main & Aux. Winch	
Max. Line Speed (1st layer)	120 m/min
Rated Line Pull (Single line)	118 kN {12.0 tf}
Wire Rope Diameter	26 mm
Wire Rope Length	275m (Main), 255 m (Aux.)
Brake Type (Free fall)	Wet-type multiple disc brake (Optional)
Working Speed	
Swing Speed	2.1 min <sup>-1</sup> {rpm}
Travel Speed	1.3/0.9 km/h

Power Plant	
Model	HINO P11C-VH
Engine Output	271 kW/1,850 min <sup>-1</sup>
Fuel Tank	400 liters
Hydraulic System	
Main Pumps	4 variable displacement
Max. Pressure	31.9 MPa {325 kgf/cm <sup>2</sup> }
Hydraulic Tank Capacity	535 liters
Self-Removal Device	
	NA
Weight	
Operating Weight	120 t *1
Ground Pressure	93.6 kPa
Counterweight	53,110 kg
Transport Weight	34,800 kg *2

Units are SI units. { } indicates conventional units.

Line speeds in table are for light loads. Line speed varies with load.

\*1 Including upper and lower machine, 53.1 ton counterweight, basic boom, hook, and other accessories.

\*2 Base Machine with boom base gantry, wire ropes (front/rear/boom hoist)

# GENERAL DIMENSIONS

(Unit: mm)

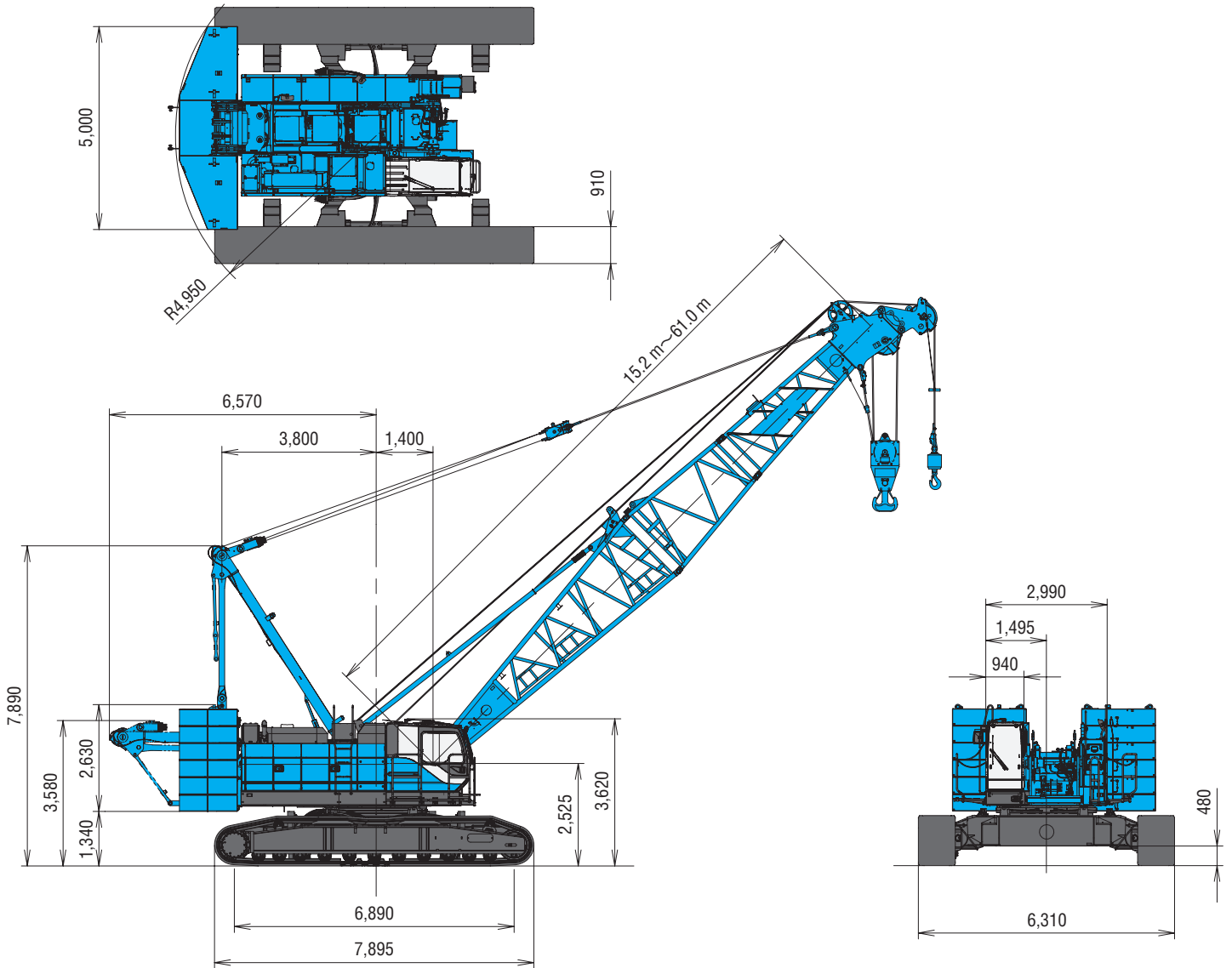

## Limit of Hook Lifting

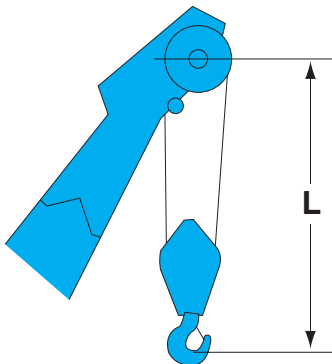

Hook	L
120 t hook	5.0 m
70 t hook	5.0 m
35 t hook	5.0 m

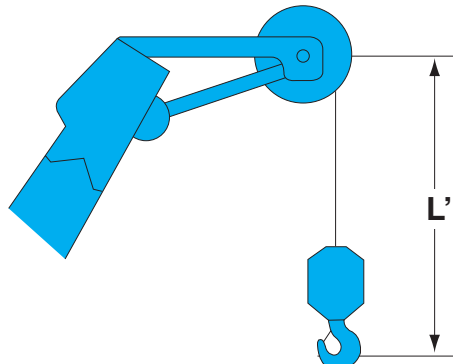

Hook	L'
Ball hook	4.2 m

# Tower Jib

(Unit: mm)

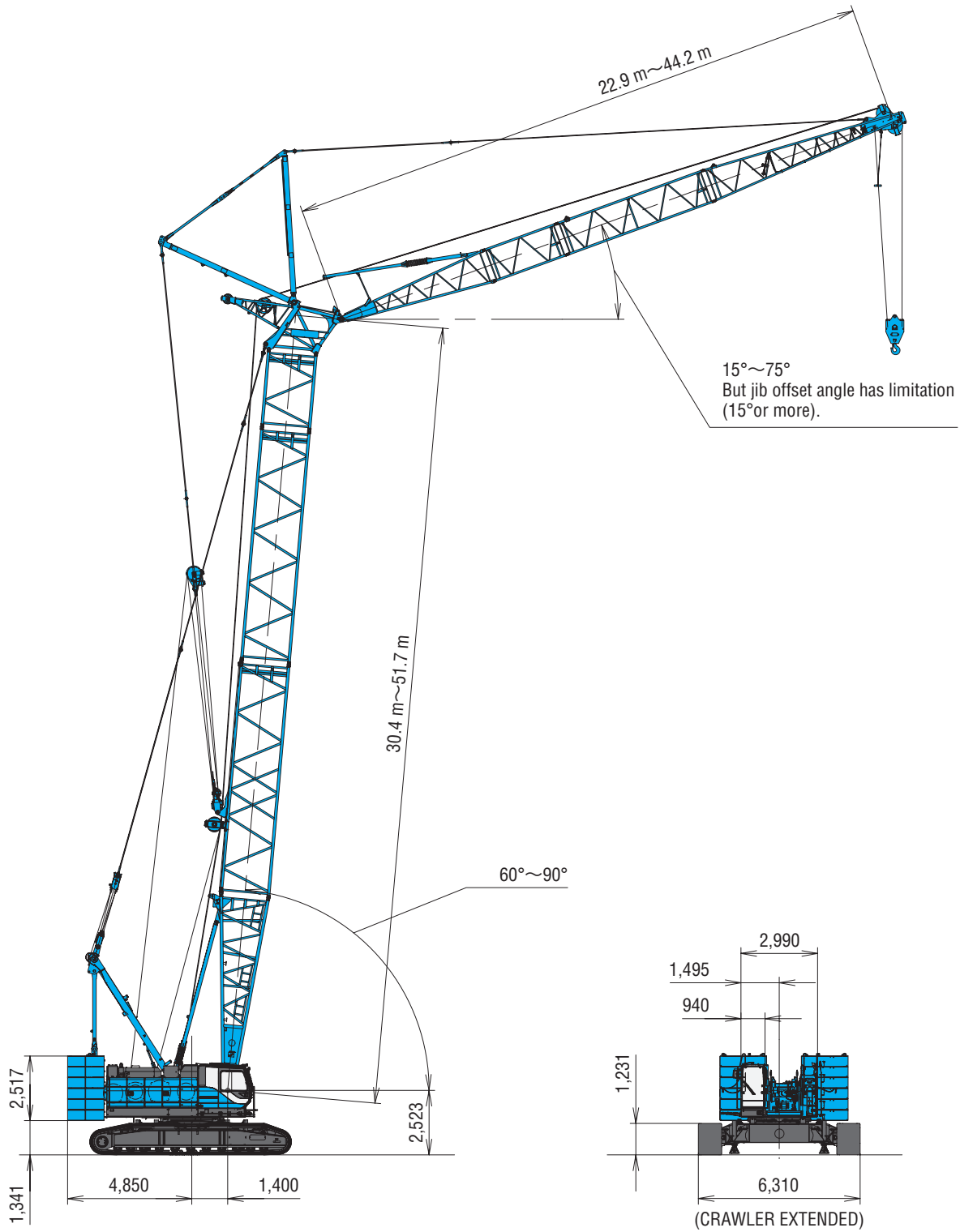

This catalog may contain photographs of machines with specifications, attachments and optional equipment.

# BOOM AND JIB ARRANGEMENTS

## Crane Boom Arrangements

Boom length m (ft)	Boom arrangement
15.2 (50)	
18.3 (60)	
21.3 (70)	
24.4 (80)	
27.4 (90)	
30.5 (100)	
33.5 (110)	
36.6 (120)	
39.6 (130)	

Boom length m (ft)	Boom arrangement
42.7 (140)	
45.7 (150)	
48.8 (160)	
51.8 (170)	
54.9 (180)	
57.9 (190)	
61.0 (200)	

Symbol	Boom Length	Remarks
	7.6 m	Boom Base
	4.6 m	Boom Top
	3.0 m	Tapered Boom
	3.0 m	Insert Boom
	6.1 m	Insert Boom
	9.1 m	Insert Boom

↗ mark shows the guy line installing position when the fixed jib is used.

※ Indicates the most flexible combination of insert booms, which can be modified to form all shorter boom arrangements.



# Long Boom Arrangements

Boom length m (ft)	Long Boom arrangement
61.0 (200)	
64.0 (210)	*
67.1 (220)	*
70.1 (230)	
73.2 (240)	*
76.2 (250)	
79.2 (260)	

Symbol	Long Boom Length	Remarks
	7.6 m	Boom Base
	7.6 m	Tower Jib Top
	3.0 m	Insert Boom
	6.1 m	Insert Boom
	9.1 m	Insert Boom
	3.0 m	Tapered Boom
	3.0 m	Relay Jib
	3.0 m	Tower Insert Jib
	6.1 m	Tower Insert Jib
	9.1 m	Tower Insert Jib

※ Indicates the most flexible combination of insert long booms, which can be modified to form all shorter long boom arrangements.

# Fixed Jib Arrangements

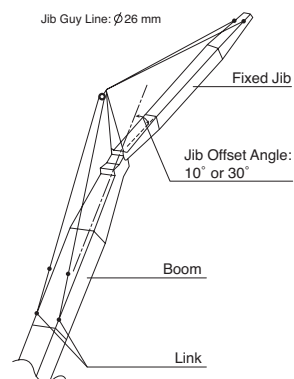

Crane boom length	Jib length m (ft)	Jib arrangement	Jib offset angle
24.4 m ~ 61.0 m	12.2 (40)		30°
	18.3 (60)		10°/30°
	24.4 (80)		10°/30°
	30.5 (100)		10°/30°





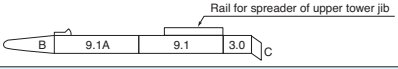
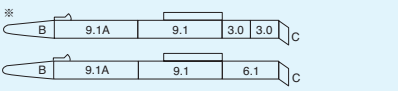
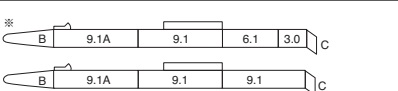
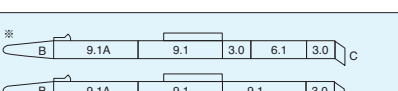
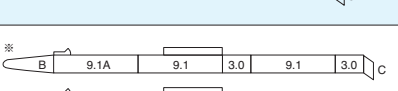
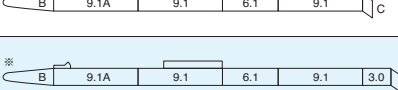
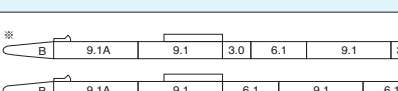
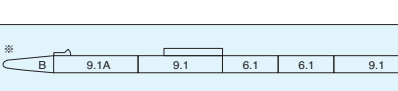

※ The jib length of 12.2 m is based on the only setting of 30 degrees offset.

Symbol	Jib Length	Remarks
	4.6 m	Jib Base
	4.6 m	Jib Top
	3.0 m	Insert Jib
	6.1 m	Insert Jib

# BOOM AND JIB ARRANGEMENTS

## Tower Arrangements



Tower length m (ft)	Tower arrangement
30.4 (100)	
33.4 (110)	
36.5 (120)	
39.5 (130)	
42.5 (140)	
45.6 (150)	
48.6 (160)	
51.7 (170)	

Symbol	Tower Length	Remarks
	7.6 m	Boom Base
	1.4 m	Tower Cap
	3.0 m	Insert Boom
	6.1 m	Insert Boom
	9.1 m	Insert Boom
	9.1 m	Special Insert Boom for Tower

※ Indicates the most flexible combination of insert tower booms, which can be modified to form all shorter tower boom arrangements.  
9.1A should be basically used in tower, and it may be also used as insert boom for crane.

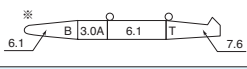
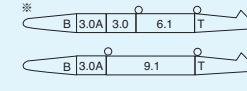
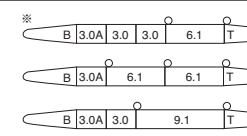
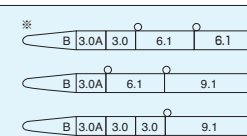
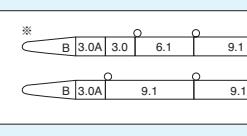
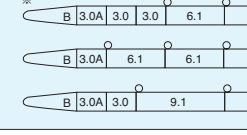
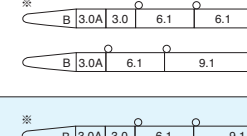
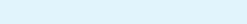
## Tower Jib Arrangements

Jib length m (ft)	Jib arrangement
22.9 (75)	
25.9 (85)	
29.0 (95)	
32.0 (105)	
35.1 (115)	
38.1 (125)	
41.1 (135)	
44.2 (145)	

Symbol	Tower Jib Length	Remarks
	6.1 m	Tower Jib Base
	7.6 m	Tower Jib Top
	3.0 m	Relay Jib
	3.0 m	Tower Insert Jib
	6.1 m	Tower Insert Jib
	9.1 m	Tower Insert Jib

※ Indicates the most flexible combination of insert tower jibs, which can be modified to form all shorter tower jib arrangements.  
○ mark indicates position where cable rollers attached

## Tower and Jib Combinations and Allowable Tower Angle

Tower length \ Jib length		Tower length								
		22.9 m	25.9 m	29.0 m	32.0 m	35.1 m	38.1 m	41.1 m	44.2 m	Pillow plate
Tower length	30.4 m	90°-60°	90°-60°	—	—	—	—	—	—	—
	33.4 m	90°-60°	90°-60°	90°-60°	90°-60°	—	—	—	—	—
	36.5 m	90°-60°	90°-60°	90°-60°	90°-60°	—	—	—	—	—
	39.5 m	90°-60°	90°-60°	90°-60°	90°-60°	90°-60°	—	—	—	—
	42.5 m	90°-60°	90°-60°	90°-60°	90°-60°	90°-60°	90°-60°	—	—	—
	45.6 m	90°-60°	90°-60°	90°-60°	90°-60°	90°-60°	90°-60°	90°-70°	—	—
	48.6 m	90°-60°	90°-60°	90°-60°	90°-60°	90°-60°	90°-70°	90°-70°	90°-70°	—
	51.7 m	90°-60°	90°-60°	90°-60°	90°-60°	90°-70°	90°-70°	90°-70°	90°-70°	Need
Hook	35 ton hook	○	○	○	○	○	○	○	○	⊗
	Ball hook	×	○	○	○	○	○	○	○	

○ : Available  
× : Not available